

MINI OSCILLATING SPRINKLER WITH STEP SPIKE



Assembly

Simply attach the sprinkler head to the top of the spike. Hold the bottom of the sprinkler head and spike to tighten by hand (do not overtighten).



Connect the Hose

Use the Quick Connect System to easily connect and disconnect the sprinkler from the hose. Connect the Product Adapter to the spike. Attach the lockable Quick Connect to the end of the hose, then simply snap in the hose to the sprinkler to begin using.

Use the additional included Product Adapter for your nozzles, wands, or other watering tools to switch between tools, even with the water running.

NOTE: If you are not using the Quick Connect System, simply connect the sprinkler directly to the hose.



To extend, simply remove the back end-cap and attach another hose and connect another sprinkler.



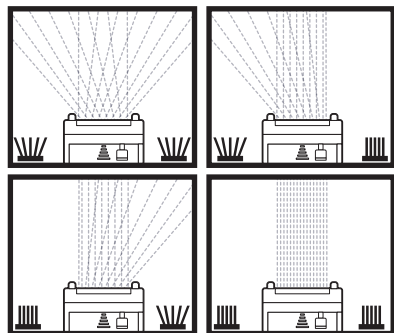
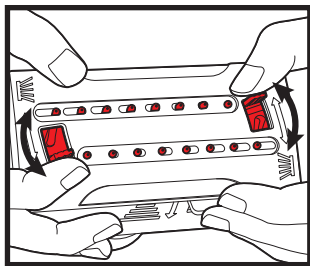

Width Control

Sliding tabs control the width.
(up to 43ft (13m))

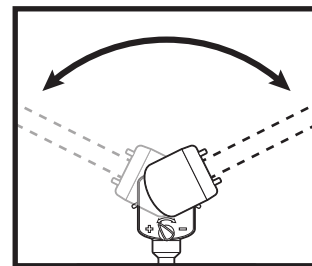
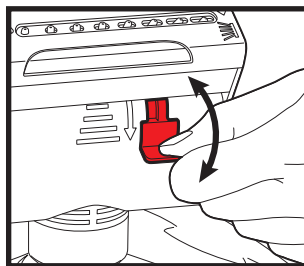
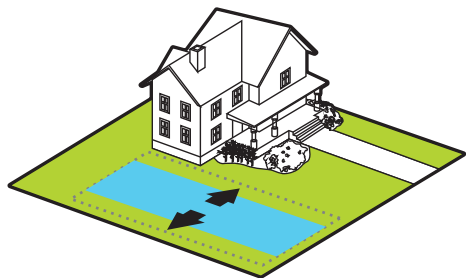

Range Control

Push down tabs control the length.
(up to 26.24 ft (8 m))

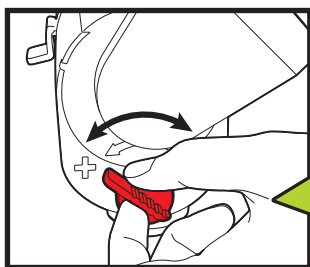
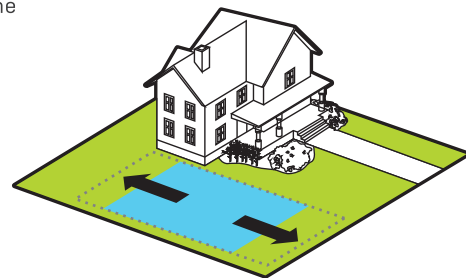

Water Flow Control

Allows adjustment of overall watering area

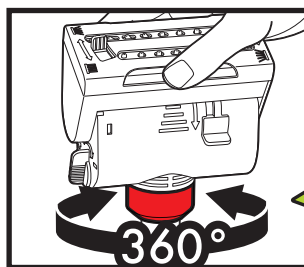

360° Rotation Adjustment

Allow simple incremental angle adjustments without moving the sprinkler and hose

⚠ CAUTION ⚠

- For outdoor use with cold water only
- Do not spray near electrical connections
- When not in use, rinse the tool with water to remove most of the dirt, dry your tool, and store indoors

⚠ WARNING: This product can expose you to chemicals including styrene, which is known to the State of California to cause cancer. For more information go to www.P65Warnings.ca.gov.

The Quick Connect Adapter (2 pcs) and Hose Connector with Water Stop (1 pc) simplify your watering experience. Simply attach the connector at the end of your hose. Then, connect the adapters to your watering tools. Interchange various tools in a snap without turning off the water as the adapter will stop the water flow. No more kinking or hose twisting as the adapter allows the hose to swivel 360 degrees.

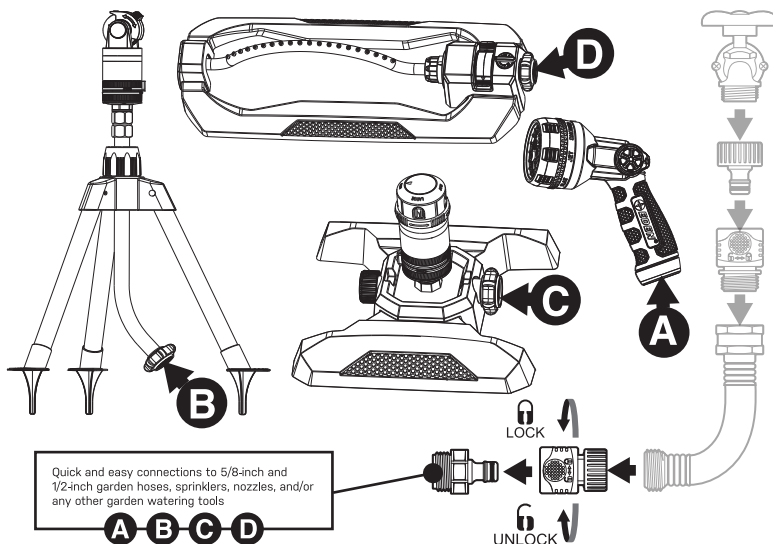

Quick and easy connections to 5/8-inch and 1/2-inch garden hoses, sprinklers, nozzles, and/or any other garden watering tools

Secure twist-and-lock mechanism prevents accidental disconnection

